

PRACTICAL THERMOCOUPLE MEASUREMENT

Noise Rejection

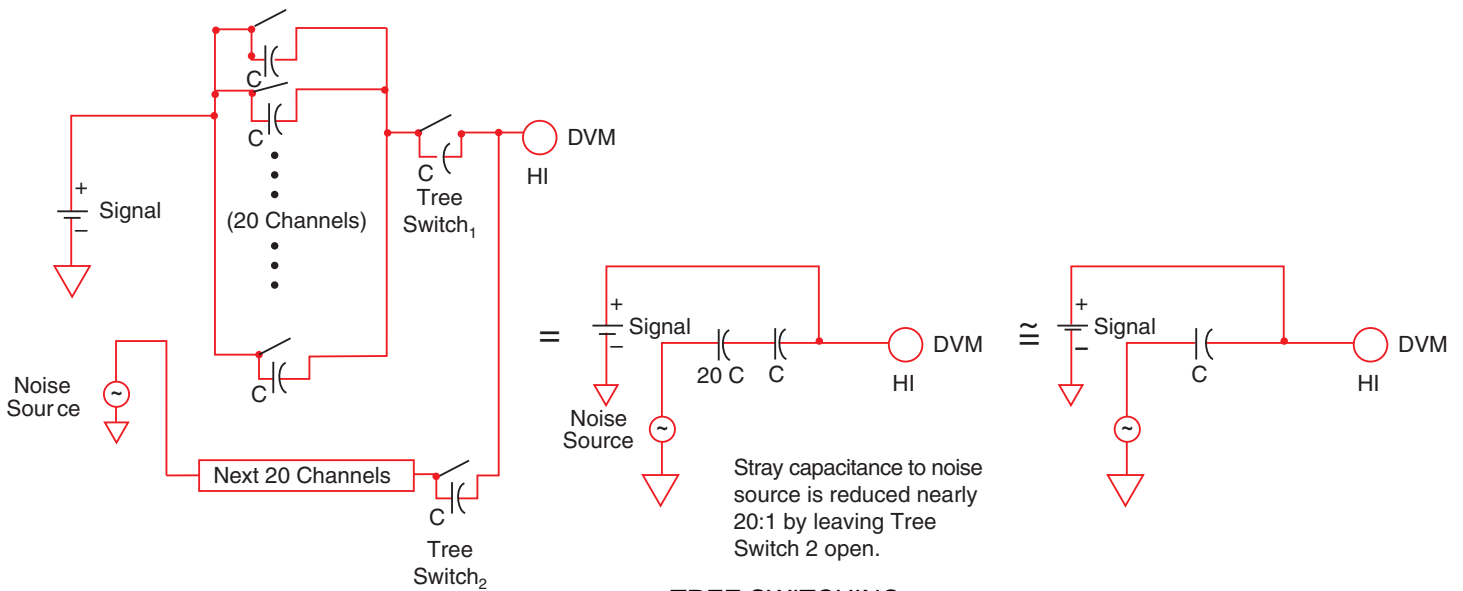

TREE SWITCHING

Figure 19

Tree Switching - Tree switching is a method of organizing the channels of a scanner into groups, each with its own main switch.

Without tree switching, every channel can contribute noise directly through its *stray* capacitance. With tree switching, groups of parallel channel capacitances are in series with a single *tree switch* capacitance. The result is greatly reduced crosstalk in a large data acquisition system, due to the reduced interchannel capacitance.

Analog Filter - A filter may be used directly at the input of a voltmeter to reduce noise. It reduces interference dramatically, but causes the voltmeter to respond more slowly to step inputs.

Integration - Integration is an A/D technique which essentially averages noise over a full line cycle; thus, power line related noise and its harmonics are virtually eliminated. If the integration period is chosen to be less than an integer line cycle, its noise rejection properties are essentially negated.

Since thermocouple circuits that cover long distances are especially susceptible to power line related noise, it is advisable to use an integrating analog-to-digital converter to measure the thermocouple voltage. Integration is an especially attractive A/D technique in light of recent innovations which allow reading rates of 48 samples per second with full cycle integration.

Guarding - Guarding is a technique used to reduce interference from any noise source that is common to both high and low measurement leads, *i.e.*, from *common mode* noise sources.

Let's assume a thermocouple wire has been pulled through the same conduit as a 220 Vac supply line. The capacitance between the power lines and the thermocouple lines will create an AC signal of approximately equal magnitude on both thermocouple wires. This *common mode* signal is not a problem in an ideal circuit, but the voltmeter is not ideal. It has some capacitance between its low terminal and safety ground (chassis). Current flows through this capacitance and through the thermocouple lead resistance, creating a normal mode noise signal. The guard, physically a floating metal box surrounding the entire voltmeter circuit, is connected to a shield surrounding the thermocouple wire, and serves to shunt the interfering current.

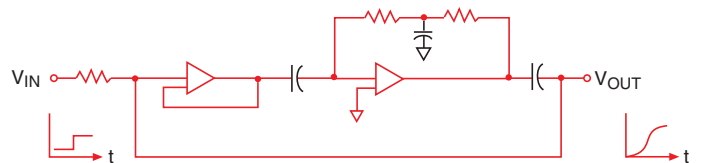

ANALOG FILTER

Figure 20

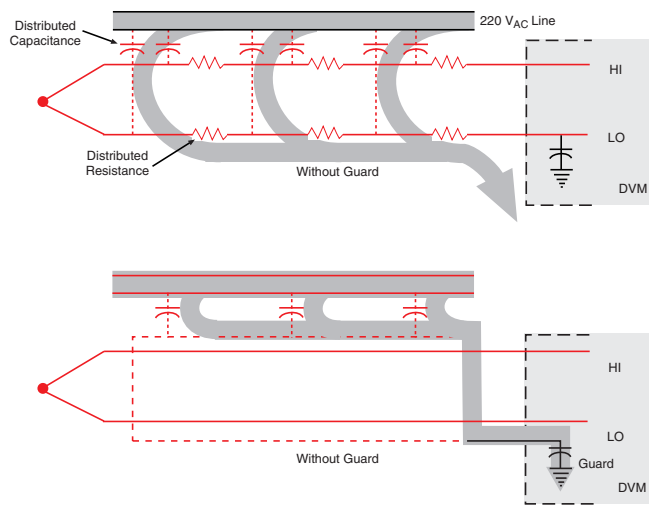

GUARD SHUNTS INTERFERING WITH CURRENT

Figure 21

Each shielded thermocouple junction can directly contact an interfering source with no adverse effects, since provision is made on the scanner to switch the guard terminal separately for each thermocouple channel. This method of connecting the shield to guard serves to eliminate *ground loops* often created when the shields are connected to earth ground.

The dvm guard is especially useful in eliminating noise voltages created when the thermocouple junction comes into direct contact with a common mode noise source.

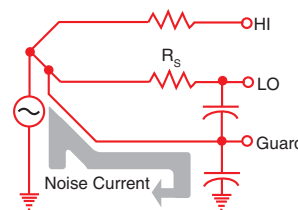

Figure 24

Notice that we can also minimize the noise by minimizing R_s . We do this by using larger thermocouple wire that has a smaller series resistance.

To reduce the possibility of magnetically induced noise, the thermocouple should be twisted in a uniform manner. Thermocouple *extension wires* are available commercially in a *twisted pair* configuration.

Practical Precautions - We have discussed the concepts of the reference junction, how to use a polynomial to extract absolute temperature data, and what to look for in a data acquisition system, to minimize the effects of noise. Now let's look at the thermocouple wire itself. The polynomial curve fit relies upon the thermocouple wire being perfect; that is, it must not become *decalibrated* during the act of making a temperature measurement. We shall now discuss some of the pitfalls of thermocouple thermometry.

Aside from the specified accuracies of the data acquisition system and its zone box, most measurement errors may be traced to one of these primary sources:

1. Poor junction connection
2. Decalibration of thermocouple wire
3. Shunt impedance and galvanic action
4. Thermal shunting
5. Noise and leakage currents
6. Thermocouple specifications
7. Documentation

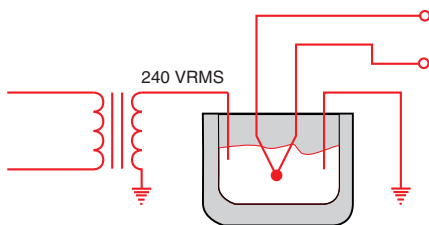

Figure 22

In Figure 22 we want to measure the temperature at the center of a molten metal bath that is being heated by electric current. The potential at the center of the bath is 120 V RMS. The equivalent circuit is:

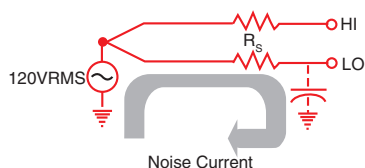

Figure 23

The stray capacitance from the dvm Lo terminal to chassis causes a current to flow in the low lead, which in turn causes a noise voltage to be dropped across the series resistance of the thermocouple, R_s . This voltage appears directly across the dvm Hi to Lo terminals and causes a noisy measurement. If we use a guard lead connected directly to the thermocouple, we drastically reduce the current flowing in the Lo lead. The noise current now flows in the guard lead where it cannot affect the reading:

Poor Junction Connection

There are a number of acceptable ways to connect two thermocouple wires: soldering, silver-soldering, welding, etc. When the thermocouple wires are soldered together, we introduce a third metal into the thermocouple circuit, but as long as the temperatures on both sides of the thermocouple are the same, the solder should not introduce any error. The solder does limit the maximum temperature to which we can subject this junction. To reach a higher measurement temperature, the joint must be welded. But welding is not a process to be taken lightly.⁵ Overheating can degrade the wire, and the welding gas and the atmosphere in which the wire is welded can both diffuse into the thermocouple metal, changing its characteristics. The difficulty is compounded by the very different nature of the two metals being joined. Commercial thermocouples are welded on expensive machinery using a capacitive-discharge technique to insure uniformity.



Junction: Fe - Pb, Sn - C \cong Fe - C

SOLDERING A THERMOCOUPLE
Figure 25

A poor weld can, of course, result in an open connection, which can be detected in a measurement situation by performing an *open thermocouple check*. This is a common test function available with dataloggers. While the open thermocouple is the easiest malfunction to detect, it is not necessarily the most common mode of failure.

Decalibration

Decalibration is a far more serious fault condition than the open thermocouple because it can result in a temperature reading that *appears* to be correct. Decalibration describes the process of unintentionally altering the physical makeup of the thermocouple wire so that it no longer conforms to the NBS polynomial within specified limits. Decalibration can result from diffusion of atmospheric particles into the metal caused by temperature extremes. It can be caused by high temperature annealing or by *cold-working* the metal, an effect that can occur when the wire is drawn through a conduit or strained by rough handling or vibration. Annealing can occur within the section of wire that undergoes a temperature gradient.

⁵ Refer to Bibliography 5

⁹ Refer to Bibliography 9

⁷ Refer to Bibliography 7

Robert Moffat in his *Gradient Approach to Thermocouple Thermometry* explains that the thermocouple voltage is actually generated by the section of wire that contains the temperature gradient, and not necessarily by the junction.⁹ For example, if we have a thermal probe located in a molten metal bath, there will be two regions that are virtually isothermal and one that has a large gradient.

In Figure 26, the thermocouple junction will not produce *any* part of the output voltage. The shaded section will be the one producing virtually the entire thermocouple output voltage. If, due to aging or annealing, the output of this thermocouple were found

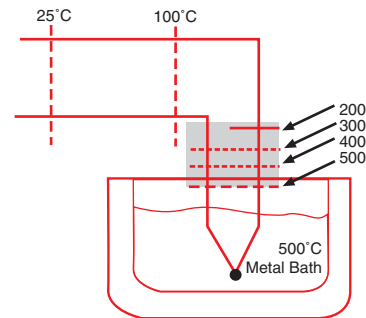

GRADIENT PRODUCES VOLTAGE
Figure 26

to be drifting, then replacing the thermocouple junction alone would not solve the problem. We would have to replace the entire shaded section, since it is the source of the thermocouple voltage.

Thermocouple wire obviously can't be manufactured perfectly; there will be some defects which will cause output voltage errors. These *inhomogeneities* can be especially disruptive if they occur in a region of steep temperature gradient. Since we don't know where an imperfection will occur within a wire, the best thing we can do is to avoid creating a steep gradient. Gradients can be reduced by using metallic sleeving or by careful placement of the thermocouple wire.

Shunt Impedance

High temperatures can also take their toll on thermocouple wire *insulators*. Insulation resistance decreases exponentially with increasing temperature, even to the point that it creates a *virtual junction*.⁷ Assume we have a completely open thermocouple operating at a high temperature.

The leakage Resistance, R_L , can be sufficiently low to complete the circuit path and give us an improper voltage reading. Now let's assume the thermocouple is not open, but we are using a very long section of small diameter wire.

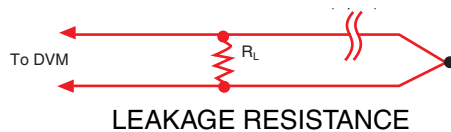

LEAKAGE RESISTANCE
Figure 27

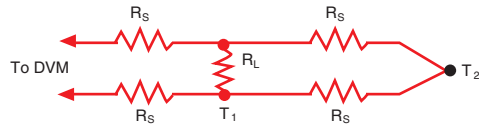

VIRTUAL JUNCTION
Figure 28

If the thermocouple wire is small, its series resistance, R_S , will be quite high and under extreme conditions $R_L \ll R_S$. This means that the thermocouple *junction* will appear to be at T_L and the output will be proportional to T_1 not T_2 .

High temperatures have other detrimental effects on thermocouple wire. The impurities and chemicals within the insulation can actually diffuse into the thermocouple metal causing the temperature-voltage dependence to deviate from published values. When using thermocouples at high temperatures, the insulation should be chosen carefully. Atmospheric effects can be minimized by choosing the proper protective metallic or ceramic sheath

Galvanic Action

The dyes used in some thermocouple insulation will form an electrolyte in the presence of water. This creates a galvanic action, with a resultant output hundreds of times greater than the Seebeck effect. Precautions should be taken to shield thermocouple wires from all harsh atmospheres and liquids.

Thermal Shunting

No thermocouple can be made without mass. Since it takes energy to heat any mass, the thermocouple will slightly alter the temperature it is meant to measure. If the mass to be measured is small, the thermocouple must naturally be small. But a thermocouple made with small wire is far more susceptible to the problems of contamination, annealing, strain, and shunt impedance. To minimize these effects, thermocouple *extension wire* can be used. Extension wire is commercially available wire primarily intended to cover long distances between the measuring thermocouple and the voltmeter.

Extension wire is made of metals having Seebeck coefficients very similar to a particular thermocouple type. It is generally larger in size so that its series resistance does not become a factor when traversing long distances. It can also be pulled more readily through a conduit than can very small thermocouple

wire. It generally is specified over a much lower temperature range than premium grade thermocouple wire. In addition to offering a practical size advantage, extension wire is less expensive than standard thermocouple wire. This is especially true in the case of platinum-based thermocouples.

Since the extension wire is specified over a narrower temperature range and it is more likely to receive mechanical stress, the temperature gradient across the extension wire should be kept to a minimum. This, according to the gradient theory, assures that virtually none of the output signal will be affected by the extension wire.

Noise - We have already discussed line-related noise as it pertains to the data acquisition system. The techniques of integration, tree switching and guarding serve to cancel most line-related interference. Broadband noise can be rejected with the analog filter.

The one type of *noise* the data acquisition system cannot reject is a dc offset caused by a dc leakage current in the system. While it is less common to see dc leakage currents of sufficient magnitude to cause appreciable error, the possibility of their presence should be noted and prevented, especially if the thermocouple wire is very small and the related series impedance is high.

Wire Calibration

Thermocouple wire is manufactured to a certain specification, signifying its conformance with the NBS tables. The specification can sometimes be enhanced by *calibrating* the wire (testing it at known temperatures). Consecutive pieces of wire on a continuous spool will generally track each other more closely than the specified tolerance, although their output voltages may be slightly removed from the center of the absolute specification.

If the wire is calibrated in an effort to improve its fundamental specifications, it becomes even more imperative that all of the aforementioned conditions be heeded in order to avoid decalibration.

Documentation - It may seem incongruous to speak of documentation as being a source of voltage measurement error, but the fact is that thermocouple systems, by their very ease of use, invite a large number of data points. The sheer magnitude of the data can become quite unwieldy. When a large amount of data is taken, there is an increased probability of error due to mislabeling of lines, using the wrong NBS curve, etc.

Since channel numbers invariably change, data should be categorized by measure and, not just channel number.⁶ Information about any given measure and, such as transducer type, output voltage, typical value and location, can be maintained in a data file. This can be done under computer control or simply by filling out a pre-printed form. No matter how the data is maintained, the importance of a concise system should not be underestimated, especially at the outset of a complex data gathering project.

Diagnostics

Most of the sources of error that we have mentioned are aggravated by using the thermocouple near its temperature limits. These conditions will be encountered infrequently in most applications. But what about the situation where we are using small thermocouples in a harsh atmosphere at high temperatures? How can we tell when the thermocouple is producing erroneous results? We need to develop a reliable set of diagnostic procedures.

Through the use of diagnostic techniques, R.P. Reed has developed an excellent system for detecting faulty thermocouples and data channels.¹⁰ Three components of this system are the event record, the zone box test, and the thermocouple resistance history.

Event Record - The first diagnostic is not a test at all, but a recording of all pertinent events that could even remotely affect the measurements. An example would be:

MARCH 18 EVENT RECORD

10:43 Power failure
 10:47 System power returned
 11:05 Changed M821 to type K thermocouple
 13:51 New data acquisition program
 16:07 M821 appears to be bad reading

Figure 29

We look at our program listing and find that measurand #M821 uses a type J thermocouple and that our new data acquisition program interprets it as a type J. But from the event record, apparently thermocouple M821 was changed to a type K, and the change was not entered into the program. While most anomalies are not discovered this easily, the event record can provide valuable insight into the reason for an unexplained change in a system measurement. This is especially true in a system configured to measure hundreds of data points.

¹⁰ Refer to Bibliography 10

Zone Box Test - A zone box is an isothermal terminal block of known temperature used in place of an ice bath reference. If we temporarily short-circuit the thermocouple directly at the zone box, the system should read a temperature very close to that of the zone box, *i.e.*, close to room temperature.

If the thermocouple lead resistance is much greater than the shunting resistance, the copper wire shunt forces $V = 0$. In the normal *unshorted* case, we want to measure T_J , and the system reads:

$$V \cong \alpha (T_J - T_{REF})$$

But, for the functional test, we have shorted the terminals so that $V=0$. The indicated temperature T'_J is thus:

$$0 = \alpha (T'_J - T_{REF})$$

$$T'_J = T_{REF}$$

Thus, for a dvm reading of $V = 0$, the system will indicate the zone box temperature. First we observe the temperature T_J (forced to be different from T_{REF}), then we short the thermocouple with a copper wire and make sure that the system indicates the zone box temperature instead of T_J .

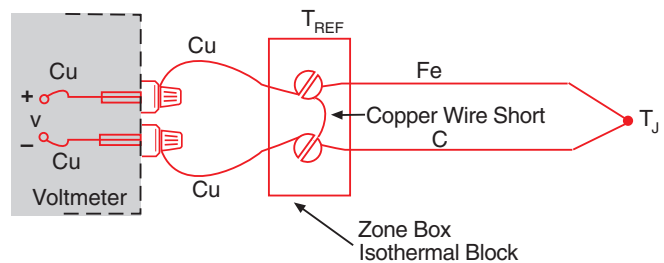

SHORTING THE THERMOCOUPLE AT THE TERMINALS
Figure 30

This simple test verifies that the controller, scanner, voltmeter and zone box compensation are all operating correctly. In fact, this simple procedure tests everything but the thermocouple wire itself.

Thermocouple Resistance - A sudden change in the resistance of a thermocouple circuit can act as a warning indicator. If we plot resistance vs. time for each set of thermocouple wires, we can immediately spot a sudden resistance change, which could be an indication of an open wire, a wire shorted due to insulation failure, changes due to vibration fatigue, or one of many failure mechanisms.

For example, assume we have the thermocouple measurement shown in Figure 31.

We want to measure the temperature profile of an underground seam of coal that has been ignited. The wire passes through a high temperature region, into a cooler region. Suddenly, the temperature we measure rises from 300°C to 1200°C. Has the burning section of the coal seam migrated to a different location, or has the thermocouple insulation failed, thus causing a short circuit between the two wires at the point of a hot spot?

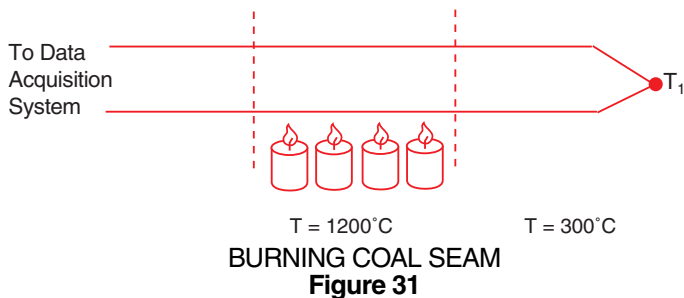

Figure 31

If we have a continuous history of the thermocouple wire resistance, we can deduce what has actually happened.

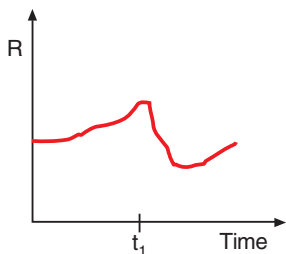

Figure 32

The resistance of a thermocouple will naturally change with time as the resistivity of the wire changes due to varying temperature. But a sudden change in resistance is an indication that something is wrong. In this case, the resistance has dropped abruptly, indicating that the insulation has failed, effectively shortening the thermocouple loop.

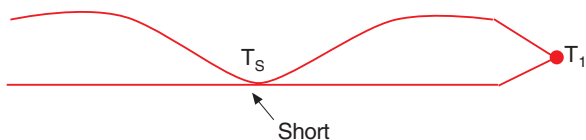

Figure 33

The new junction will measure temperature T_s , not T_1 . The resistance measurement has given us additional information to help interpret the physical phenomenon detected by a standard *open thermocouple* check.

Measuring Resistance - We have casually mentioned checking the resistance of the thermocouple wire as if it were a straightforward measurement. But keep in mind that when the thermocouple is producing a voltage, this voltage can cause a large resistance measurement error. Measuring the resistance of a thermocouple is akin to measuring the internal resistance of a battery. We can attack this problem with a technique known as *offset compensated ohms measurement*.

As the name implies, the voltmeter first measures the thermocouple offset voltage without the ohms current source applied. Then the ohms current source is

switched on and the voltage across the resistance is measured again. The voltmeter software compensates for the offset voltage of the thermocouple and calculates the actual thermocouple source resistance.

Special Thermocouples - Under extreme conditions, we can even use diagnostic thermocouple circuit configurations. *Tip-branched* and *leg-branched* thermocouples are four-wire thermocouple circuits that allow redundant measurement of temperature, noise, voltage and resistance for checking wire integrity. Their respective merits are discussed in detail in REF. 8.

Only severe thermocouple applications require such extensive diagnostics, but it is comforting to know that there are procedures that can be used to verify the

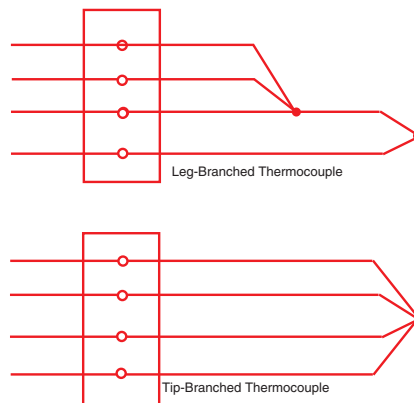

Figure 34

Summary

In summary, the integrity of a thermocouple system can be improved by following these precautions:

- Use the largest wire possible that will not shunt heat away from the measurement area.
- If small wire is required, use it only in the region of the measurement and use extension wire for the region with no temperature gradient.
- Avoid mechanical stress and vibration which could strain the wires.
- When using long thermocouple wires, connect the wire shield to the dvm guard terminal and use twisted pair extension wire.
- Avoid steep temperature gradients.
- Try to use the thermocouple wire well within its temperature rating.
- Use a guarded integrating A/D converter.
- Use the proper sheathing material in hostile environments to protect the thermocouple wire.
- Use extension wire only at low temperatures and only in regions of small gradients.
- Keep an event log and a continuous record of thermocouple resistance.